



Sea-Bird Electronics, Inc.
 13431 NE 20th Street
 Bellevue, WA 98005
 USA

Phone: (425) 643-9866
 Fax: (425) 643-9954
 E-mail: seabird@seabird.com
 Website: www.seabird.com

APPLICATION NOTE NO. 64-1

revised April 2008

Plumbing Installation - SBE 43 DO Sensor and Pump on a CTD

This Application Note describes installation of an SBE 43 Dissolved Oxygen (DO) Sensor and pump (and associated plumbing) for:

- Profiling applications – on an SBE *9plus* CTD, using PN 90087 Universal Plumbing Kit. The plumbing guidelines for the SBE *9plus* also apply to an SBE 19, *19plus*, *19plus V2*, or 25 CTD, except as noted.
- Moored applications - on an SBE *16plus*, *16plus-IM*, *16plus V2*, *16plus-IM V2*, or SBE *19plus* or *19plus V2* (used in moored mode), using PN 90087 Universal Plumbing Kit.

PROFILING APPLICATIONS

Preparation

Parts Included in PN 90087 Universal Plumbing Kit

PN	Description	Quantity
23337	Pump air release valve - for vertical configuration only	1
30387	Tube, 1/2" Y-fitting - for connection to pump air release valve, vertical configuration only	1
30388	Tygon tubing, 19 mm (0.75 in.) OD, 13 mm (0.5 in.) ID	4 ft
30579	Tygon tubing, 13 mm (0.5 in.) OD, 9.5 mm (0.375 in.) ID - for connections to DO sensor	0.5 ft
30389	Cable tie, 102 mm (4 in.) - to secure tubing connections	20
30458	Cable tie, 381 mm (15 in.) - to secure Y-fitting to main housing	2

Tools Required

Sharp knife or scalpel for cutting tubing
 Straight-edge ruler for measuring and cutting

Installation

Note for SBE *9plus* or 25:

If your conductivity sensor does not have a conductivity tube support, install the conductivity tube support kit before installing the plumbing (see Application Note 36 for installation details).

Conductivity tube support kit:
 Part Number 50094 for aluminum sensors
 Part Number 50108 for titanium sensors

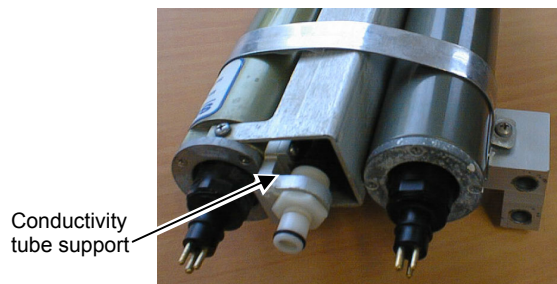

Basic considerations for plumbing installation:

- Use the minimum tubing lengths necessary, but avoid tight bends in the tubing. Tight bends place stress on the tubing connections at the sensors, which can lead to failures at the connections.
- Do not create any vertical loops in the tubing. Loops trap air, preventing the pump from working properly.
- Secure each tubing connection with two cable ties.

Plumbing installation details differ, depending on whether the sensors will be deployed in a horizontal or vertical configuration, as explained in the following sections.

Horizontal Configuration Schematic and Details

The horizontal configuration is most commonly used when the CTD is integrated with an SBE 32 Carousel Water Sampler with an extension stand. When installing plumbing for the horizontal configuration:

- Configure the system as follows:
 - Place the DO sensor intake above the conductivity sensor exhaust.
 - Place the pump intake above the DO sensor exhaust.
 - Orient the pump with the exhaust outlet *corner* up.
- Failure to configure the system in this manner can trap air, preventing the pump from working properly.
- Place a 13 mm (0.5 inch) long piece of the 9.5 mm ID Tygon tubing at the DO sensor intake and exhaust. Slide the larger diameter tubing (13 mm ID) over the smaller diameter tubing to provide tight seals.
- SBE 5T titanium pump, which is standard for the *9plus*, is shown in the diagram. SBE 5P plastic pump has the same operational characteristics, and may be ordered with the SBE 19, *19plus*, *19plus* V2, or 25 CTD for deployments to 600 m.
- If the system does not include a DO sensor, connect the tubing from the conductivity cell directly to the pump intake.

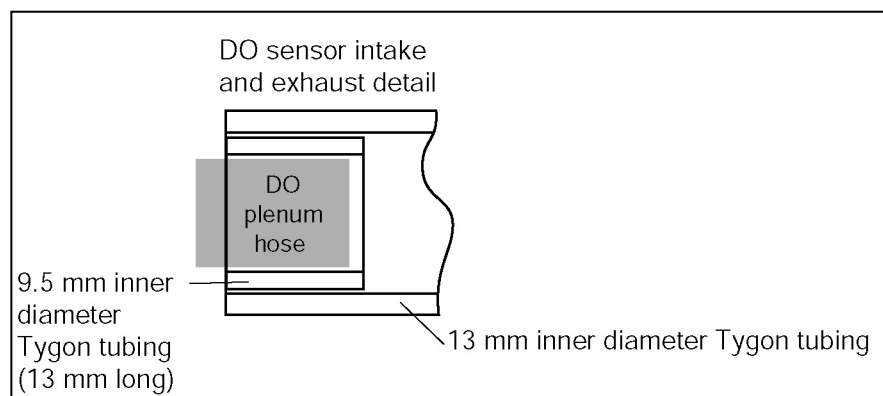
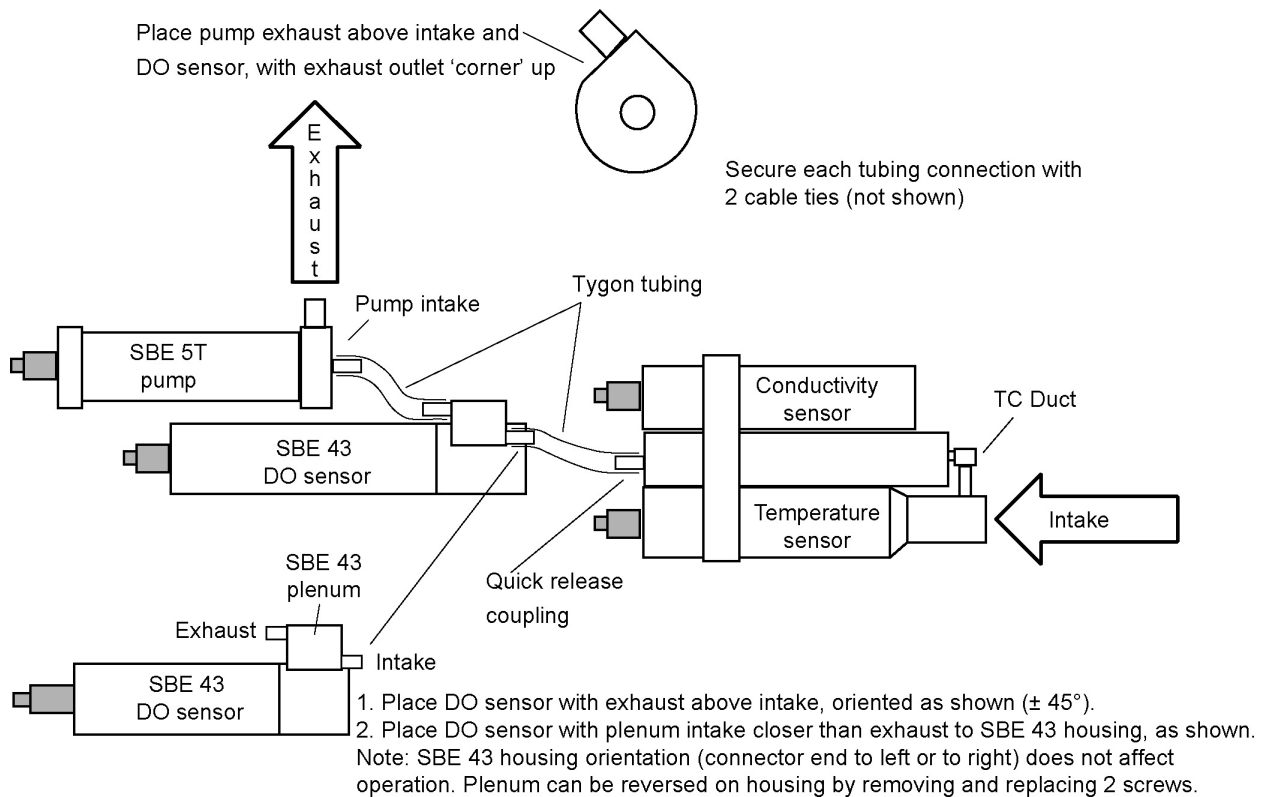

Horizontal Configuration Schematic and Details (continued)

Secure each tubing connection with two cable ties (not shown).

Overall View

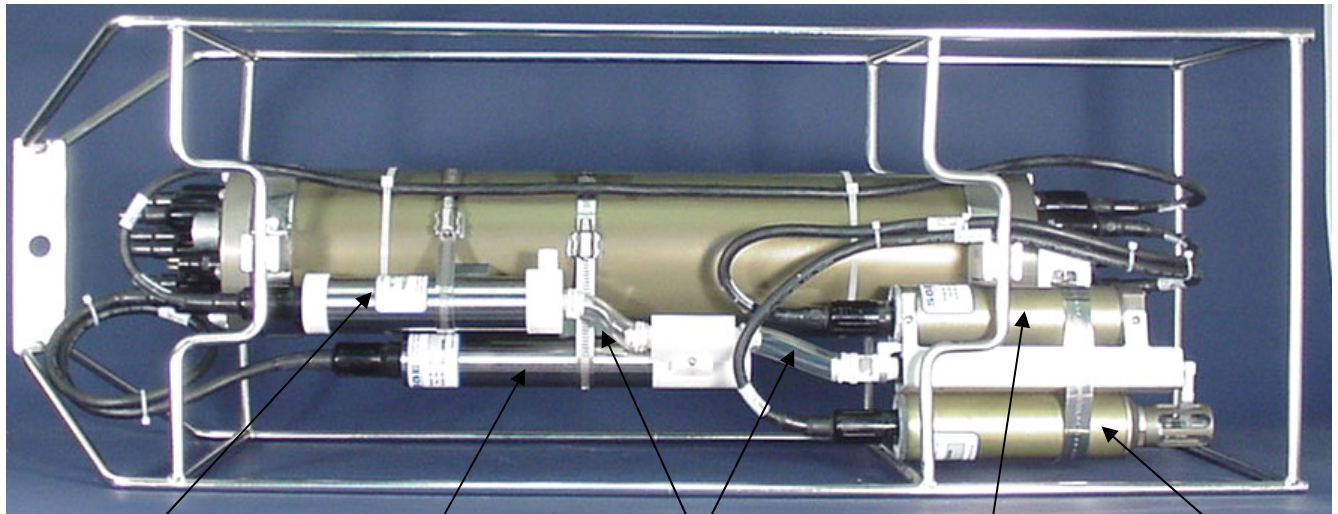

Pump
(vertically above
DO sensor)

DO sensor
(plenum intake vertically
above conductivity sensor
exhaust)

Tygon
tubing

Conductivity sensor

Temperature sensor

Details

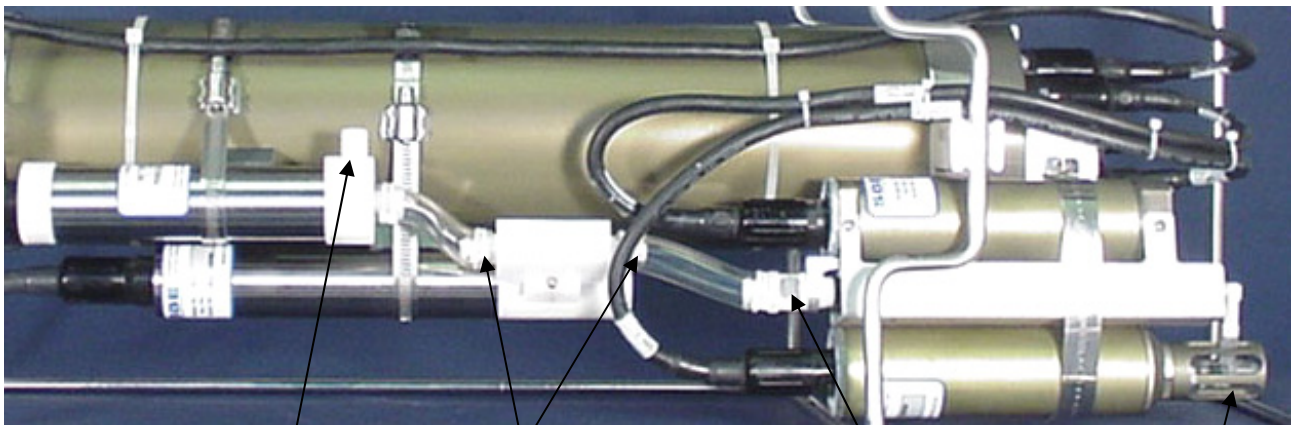

Pump exhaust –above DO
sensor and TC Duct intake,
oriented as shown below

Slide larger diameter Tygon
tubing over smaller diameter
Tygon tubing to provide tight
seal at DO sensor

Quick release
coupling on
conductivity cell

TC Duct intake

Orient with *corner*
vertically above
pump intake



Vertical Configuration Schematic and Details

When installing plumbing for the vertical configuration:

- (For SBE *9plus* only) Place the opening of the intake and exhaust on the same horizontal plane. Attach exhaust tubing from the pump to the cage, as shown in the schematic below. Failure to place the exhaust tubing properly can lead to acceleration of water in the plumbing, with resulting errors in conductivity data.
Note: Exhaust tubing is usually omitted by Sea-Bird for an SBE 19, *19plus*, *19plus V2*, or 25.
- Place the exhaust away from the intake, so that exhaust water is not pulled into the intake. If the exhaust is too close to the intake, it will cause errors in temperature data, because the pump transfers heat to the exhaust water.
- Place a 13 mm (0.5 inch) long piece of 9.5 mm ID Tygon tubing at the DO sensor intake and exhaust. Slide the larger diameter Tygon tubing (13 mm ID) over the smaller diameter tubing to provide tight seals.
- SBE 5T titanium pump, which is standard for the *9plus*, is shown in the diagram. SBE 5P plastic pump has the same operational characteristics, and may be ordered with the SBE 19, *19plus*, *19plus V2*, or 25 CTD for deployments to 600 m.
- If the system does not include a DO sensor, connect the tubing from the conductivity cell directly to the Y-fitting.

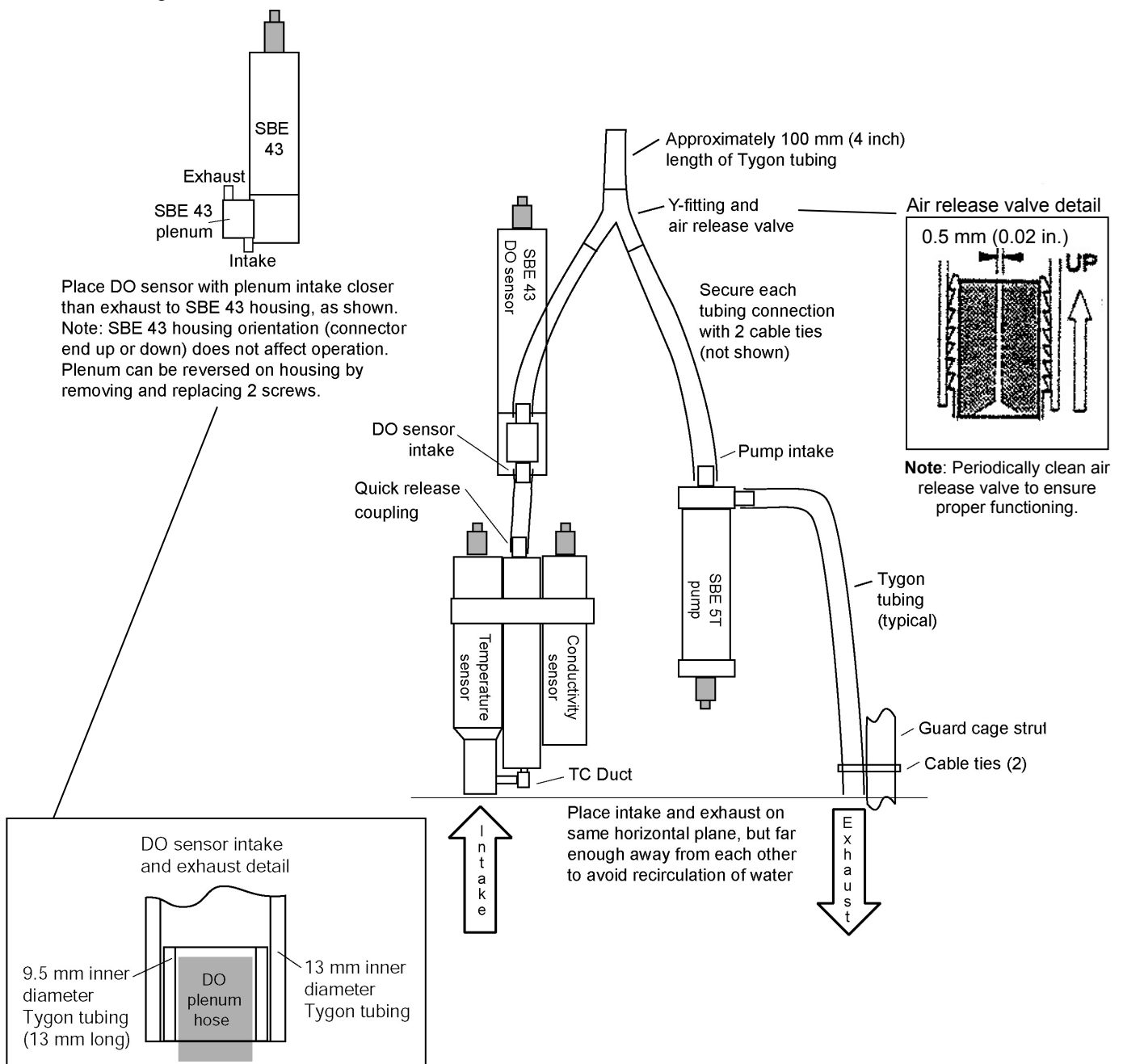

Vertical Configuration Schematic and Details (continued)

Secure each tubing connection with two cable ties.

Overall View

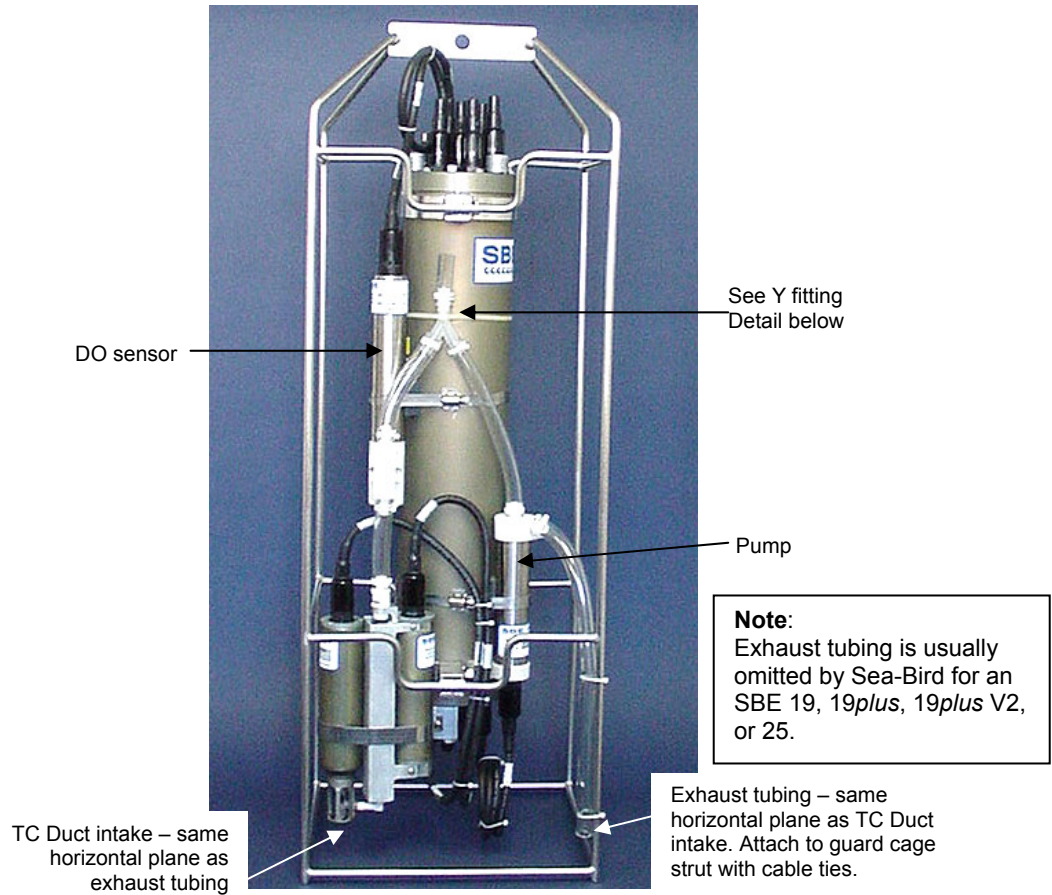

Temperature/Conductivity to DO Sensor Detail

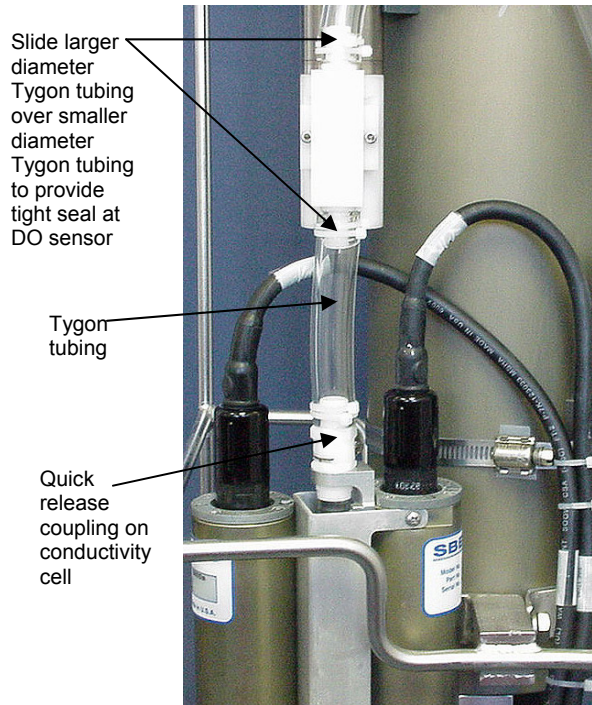

Y Fitting Detail

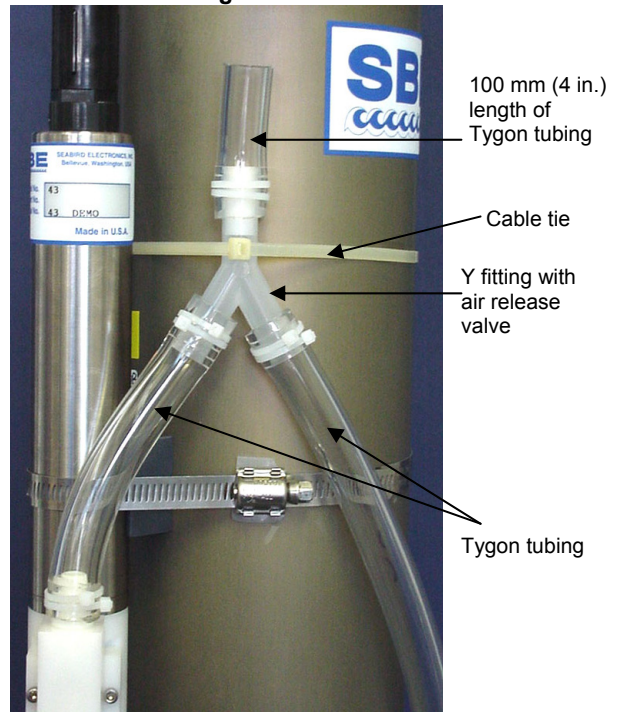

MOORED APPLICATIONS

Preparation

Parts Included in PN 90087 Universal Plumbing Kit

PN	Description	Quantity
30388	Tygon tubing, 19 mm (0.75 in.) OD, 13 mm (0.5 in.) ID	4 ft
30579	Tygon tubing, 13 mm (0.5 in.) OD, 9.5 mm (0.375 in.) ID - for connections to DO sensor	0.5 ft
30389	Cable tie, 102 mm (4 in.) - to secure tubing connections	20
23337	<i>Pump air release valve - not used for moored applications</i>	1
30387	<i>Tube, 1/2" Y-fitting - not used for moored applications</i>	1
30458	<i>Cable tie, 381 mm (15 in.) - not used for moored applications</i>	2

Tools Required

Sharp knife or scalpel for cutting tubing
Straight-edge ruler for measuring and cutting

Installation

Basic considerations for plumbing installation:

- Use the minimum tubing lengths necessary, but avoid tight bends in the tubing. Tight bends place stress on the tubing connections at the sensors, which can lead to failures at the connections.
- Do not create any vertical loops in the tubing. Loops trap air, preventing the pump from working properly.
- Secure each tubing connection with two cable ties.
- Configure the system as follows:
 - Place the DO sensor intake above the conductivity sensor exhaust.
 - Orient the DO sensor plenum with the intake closer than the exhaust to the sensor body.
 - Place the pump intake above the DO sensor exhaust.Failure to configure the system in this manner can trap air, preventing the pump from working properly.
- Place a 13 mm (0.5 inch) long piece of the 9.5 mm ID Tygon tubing at the DO sensor intake and exhaust. Slide the larger diameter tubing (13 mm ID) over the smaller diameter tubing to provide tight seals.
- If the system does not include a DO sensor, connect the tubing from the conductivity cell directly to the pump intake.

Schematic and Details

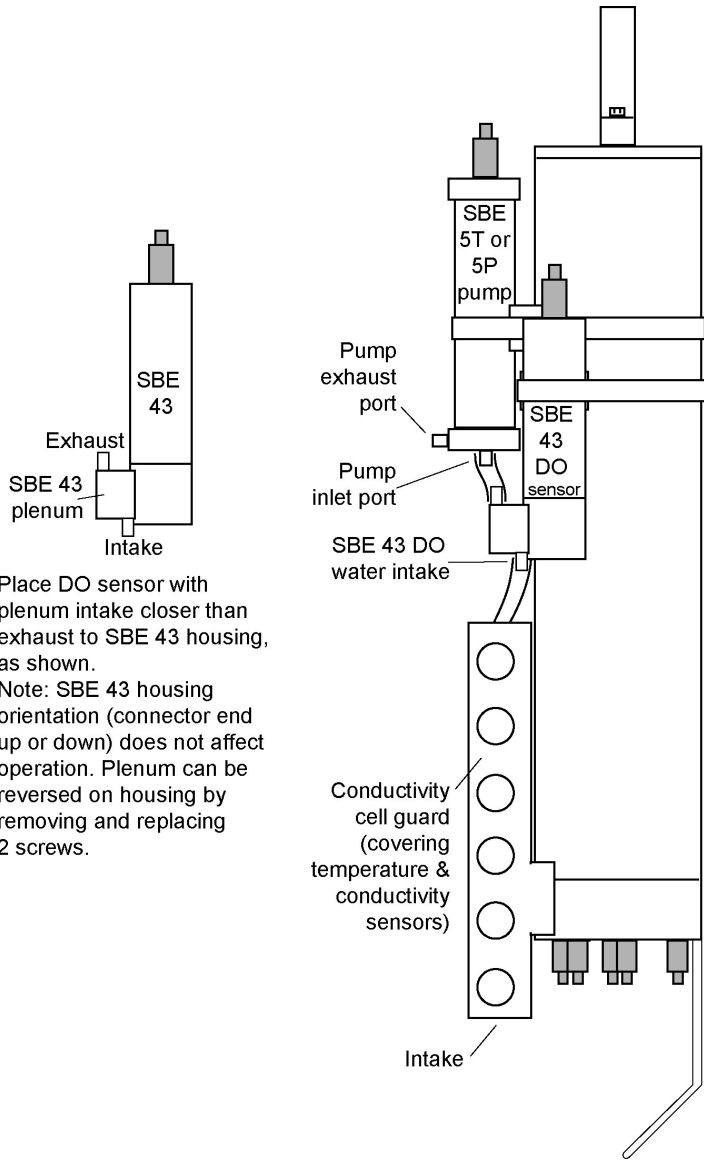

Place DO sensor with plenum intake closer than exhaust to SBE 43 housing, as shown.
 Note: SBE 43 housing orientation (connector end up or down) does not affect operation. Plenum can be reversed on housing by removing and replacing 2 screws.

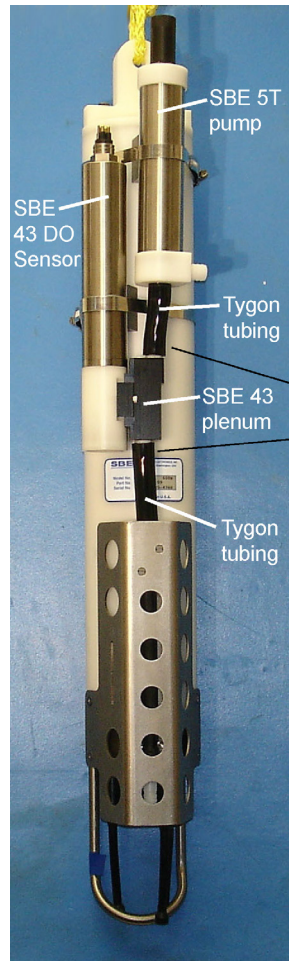

Cables omitted for clarity

At DO sensor, slide larger diameter Tygon tubing over smaller diameter Tygon tubing to provide tight seal

Orient SBE 43 plenum as shown, with intake closer to body of SBE 43